

# VE.Direct Bluetooth Smart dongle

# Table of Contents

<b>1. Introduction</b> .....	<b>1</b>
1.1. Introduction .....	1
1.2. Features .....	1
1.3. Limitations .....	2
1.4. Compatible products .....	2
1.5. The VictronConnect App .....	2
<b>2. Installation</b> .....	<b>5</b>
<b>3. Operation</b> .....	<b>6</b>
3.1. LED Status codes Bluetooth module .....	6
3.2. Update firmware .....	6
<b>4. Troubleshooting and Support</b> .....	<b>8</b>
4.1. Unable to connect to the dongle .....	8
<b>5. Warranty</b> .....	<b>9</b>
<b>6. Specifications</b> .....	<b>10</b>
6.1. Enclosure dimensions .....	10

# 1. Introduction

## 1.1. Introduction

The VE.Direct Bluetooth Smart Dongle connects to a non-Bluetooth VE.Direct Victron product which can then be accessed via Bluetooth using the [VictronConnect app](#) for easy monitoring, setup and firmware update purposes.

The dongle can be used with any Victron Energy product that is equipped with a VE.Direct port (with exception of GX devices. It is especially useful for products that do not have built-in Bluetooth, such as: [BMV 700 and 702 battery monitors](#), [Phoenix Inverters VE.Direct](#) or the [BlueSolar MPPT Solar Charge Controllers](#).

For additional documentation relating to the dongle, like product photos, certificates and more, also see the [VE.Direct Bluetooth Smart dongle](#) product page.



The VE.Direct Bluetooth Smart dongle was previously called the VE.Direct to Bluetooth LE dongle. There are no differences, only the name has changed from LE to Smart.

## 1.2. Features

The main features of the VE.Direct Bluetooth Smart Dongle are:

- View data (such as battery status and solar panel power as well as other useful data) from non-smart devices such as BlueSolar MPPTs, Phoenix Inverter VE.Direct and BMV wirelessly on your iOS or Android mobile devices via our [VictronConnect app](#).
- VE.Smart Networking: wireless communication network between Victron products. See the full [VE.Smart Networking manual](#) and also the [Limitation chapter \[2\]](#) for more information.
- Bluetooth live data advertisement support: greater range and instant display of the most important data live on the VictronConnect app. See the [VictronConnect manual](#) for more information (requires firmware 2.41 or later).
- Works with iOS, Android and macOS.
- Two status LEDs for Bluetooth and errors.
- Clear PIN code button.

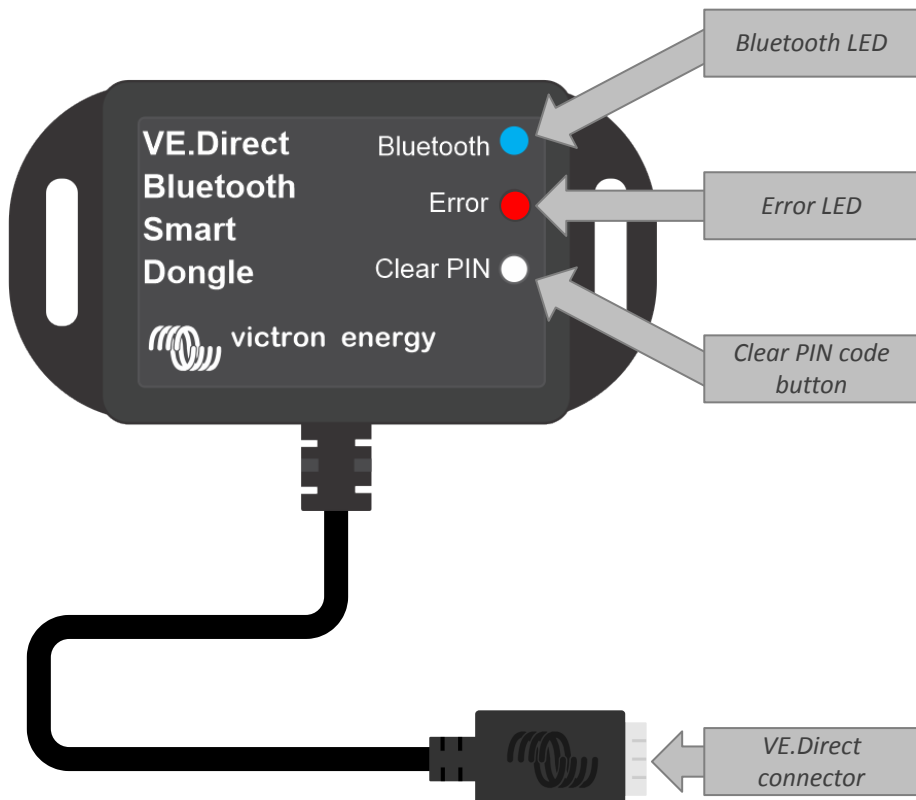

### 1.3. Limitations

There are a few limitations to be aware of:

- The VE.Direct Bluetooth Smart Dongle is not compatible with Windows PC.
- Synchronised charging is not possible with VE.Smart Networking.
- Stored trends is not supported.
- "Keep SOC" option is not supported for the Battery SOC on reset setting.
- Bluetooth GATT service is not supported.

### 1.4. Compatible products

The dongle can be connected to almost all Victron products that have a built-in VE.Direct port.

For a full list see the "Compatible Victron Products" section of the [VictronConnect manual](#).



The dongle cannot be connected to a GX device or to a GlobalLink device

### 1.5. The VictronConnect App

To connect to the Victron product via the dongle:

- Open the VictronConnect App.
- The Victron app will establish communication with the dongle and the Victron product.
- When the connection is active, the blue Bluetooth LED will stop blinking and turn on solid.
- The product where the dongle is connected to will show up in the device list of the VictronConnect App.
- It will be called VE.Direct smart, together with the name of the connected Victron product. The name can be changed if desired.
- Select "VE.Direct smart" from the VictronConnect App device list.
- The Victron product can now be accessed via the dongle and VictronConnect App.
- Use the VictronConnect App to monitor, make settings or update firmware of the Victron product.

For more information on monitoring and product settings, see the [VictronConnect product page](#) and also see the product manual of the Victron product the dongle is connected to.

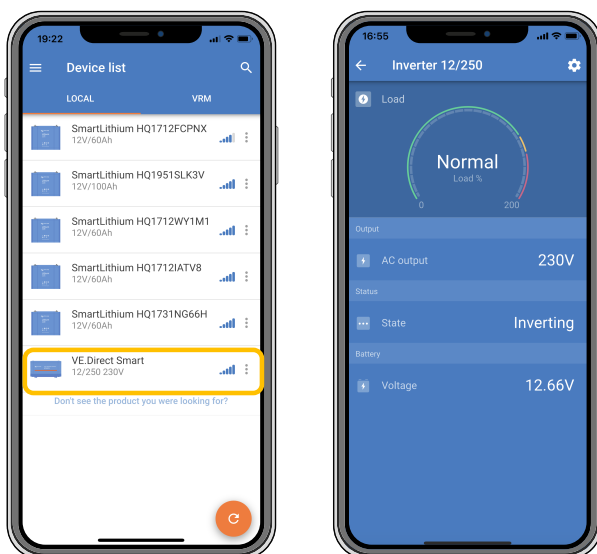

Example of VictronConnect device list and the product page of an inverter

To access the dongle information via the VictronConnect App:

- Click on the cog symbol in the top right of the product screen to go to the settings page.

- Click on the 3 dots  symbol in the top right hand corner of the settings screen.
- Select "Product info" from the pop-up window, the product page will open.
- Scroll down on the product info page to see the dongle information

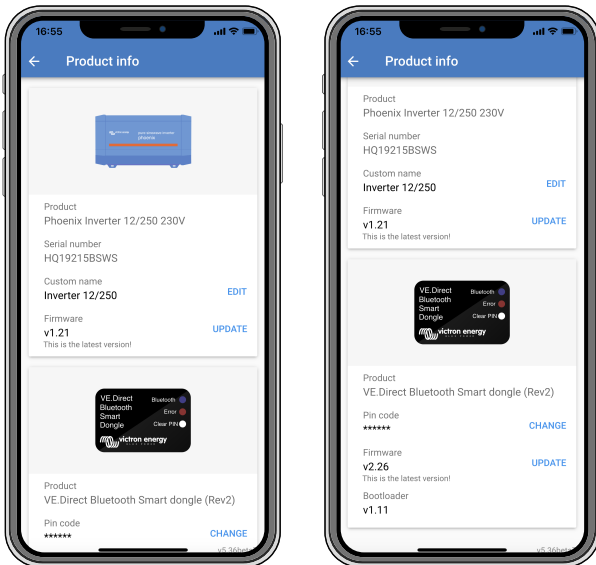

*VictronConnect dongle information page*

### Enable Bluetooth Live Data Advertisement

Bluetooth Live Data Advertisement allows to view data of the connected VE.Direct product instantly and without connecting to it.

If a firmware update to version 2.41 or later of the VE.Direct Bluetooth Smart Dongle is carried out via the VictronConnect app, a pop-up window will appear after the update in which Bluetooth live data advertisement can be activated automatically. The live data then appear immediately in the device overview.

It is also possible to subsequently activate or deactivate Bluetooth live data advertisement. The following steps are required for this:

1. Open the VictronConnect app and tap on the VE.Direct dongle to open it.
2. Go to the Product info page (see the section above: **To access the dongle information via the VictronConnect app**) and check that firmware v2.41 or later is installed.
3. Scroll to the bottom of the page and use the slider to enable/disable Bluetooth live data advertisement.

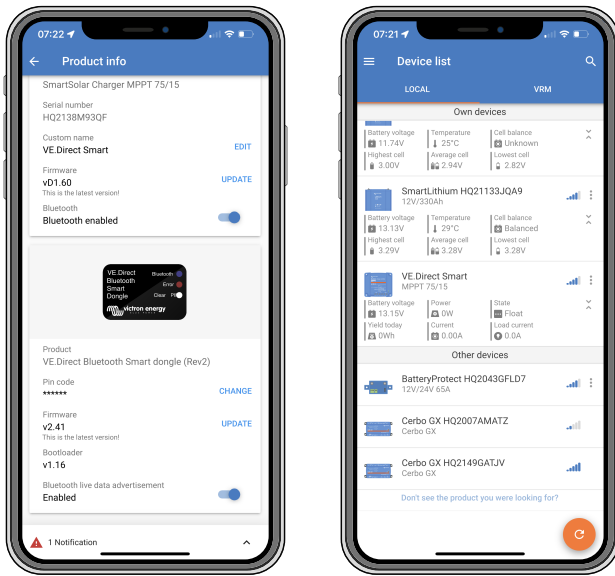

*Bluetooth live data advertisement enabled and instant live data on the Device list*

## 2. Installation

- Connect the dongle directly to the VE.Direct port of a compatible Victron product.
- Ensure that the compatible Victron product has been powered up so that the dongle is also powered.
- On power-up, the blue LED will blink, and the red LED will quickly flash. The red LED will give a short flash to confirm that the red LED is functional.
- Connect to the dongle using the VictronConnect app.
- If a firmware update is required, the blue and red LED will blink fast in an alternating fashion. The VictronConnect app will automatically update the firmware.
- If a firmware update is not required, the blue LED will slowly blink and the red LED is off.
- Once the VictronConnect App has established a successfully connection with the dongle (and the firmware was successfully updated), the blue LED will be on and the red LED will be off.
- Quite often, the firmware of the connected Victron product will also be updated on first connection.



It is not possible to extend the 1.5m VE.Direct cable.

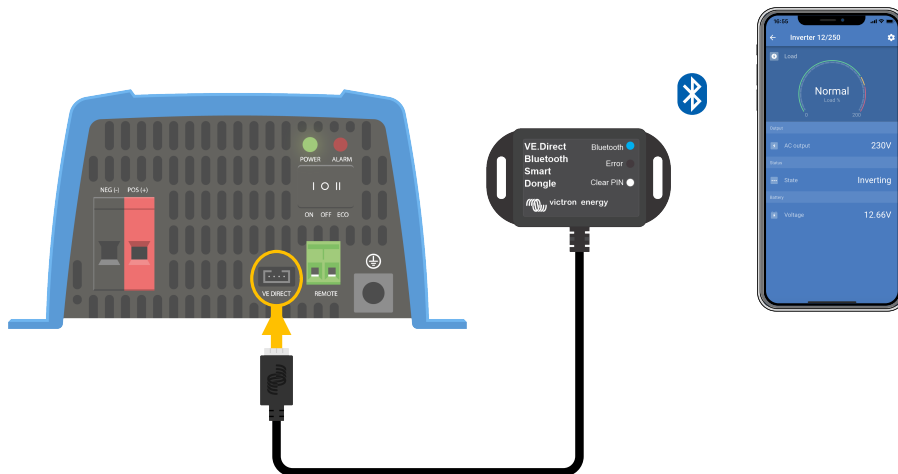

Connection drawing VE.Direct Bluetooth Smart Dongle

## 3. Operation

As soon as the Victron product where the dongle is connected to, is powered up, the dongle will also be powered.

The blue Bluetooth LED will be slowly blinking. This means that the dongle is ready for connection.

### 3.1. LED Status codes Bluetooth module

The Bluetooth status LED (blue) and an the error LED are both associated with the Bluetooth interface.

- On power-up, the blue LED will blink, and the red LED will quickly flash. The red LED will give a short flash to confirm that the red LED is functional.
- When the blue LED is blinking, the Bluetooth interface is ready to be connected to the VictronConnect App.
- When the blue LED stays on, the Bluetooth interface has successfully connected to VictronConnect App via Bluetooth.

See below table for an overview of all possible LED combinations of the Bluetooth module and their meaning.

**Table 1. LED indications Bluetooth module**

Blue LED	RED LED	Operational state	Connection state	Description
Slow blinking	Off	VE.Direct gateway	Not connected	Ready for connection via Bluetooth
On	Off	VE.Direct gateway	Connected	Bluetooth successfully connected
On	On	VE.Direct gateway	Connected	VE.Direct communication problem. Only the dongle itself can be updated in VictronConnect.
Slow blinking	Slow blinking	VE.Direct gateway	Not connected	VE.Direct communication problem. The dongle will only advertise itself and the attached device will not be visible in VictronConnect.
Double flash	Double flash	VE.Direct gateway	Not connected	Confirmation that the PIN code has been cleared
Fast blinking and alternating with red LED	Fast blinking and alternating with blue LED	Firmware update	Not connected	Red and blue LED are alternating - The firmware needs to be updated
On	Fast blinking	Firmware update	Connected	The firmware is being updated
On	Slow blinking	Firmware update	Programming	The firmware is being updated

### 3.2. Update firmware

If the blue and red LED are blinking alternating fast this means that the dongle firmware needs to be updated. This usually occurs during installation when the dongle is powered up for the first time.

**To update the firmware on first install:**

- Connect to the dongle with VictronConnect.
- Once connected VictronConnect will automatically initiate the firmware update.





Screenshot dongle firmware update using VictronConnect

**To check the firmware version or to manually update:**

- Go to the product info screen as described in previous chapter
- Check the firmware version
- If the latest version is installed, no action is needed
- If there is a newer version available, use the "UPDATE" link to update to the latest version

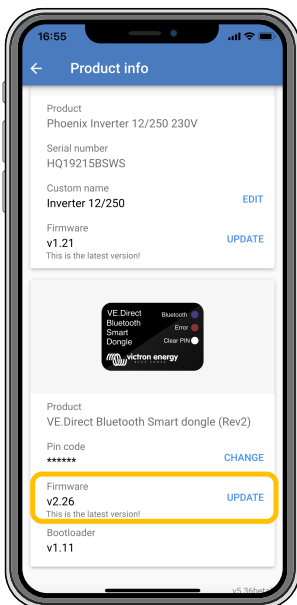

Screenshot dongle firmware version overview VictronConnect

## 4. Troubleshooting and Support

Consult this chapter in case of unexpected behaviour or if you suspect a product fault.

The correct troubleshooting and support process is to first consult the common issues as described in this chapter.

Should this fail to resolve the issue, contact the point of purchase for technical support. If the point of purchase is unknown, refer to the [Victron Energy Support webpage](#).

### 4.1. Unable to connect to the dongle

How to fix or diagnose connection problems:

- Make sure that the Victron product where the dongle is connected to, is listed in the "compatible Victron products " chapter in the [VictronConnect manual](#).
- The dongle is powered via the VE.Direct cable connection. Check that the device where the dongle connects to, is powered and the LEDs blink when connecting to the VE.Direct port.
- Make sure you are close enough to the dongle. In open space, a distance of up to approximately 20 meters should work.
- Only one phone or tablet can be connected to a dongle at the same time. Make sure no other devices are connected to the dongle, and try again.
- Try to disconnect the dongle and reconnect it to the same product.
- Try to connect the dongle to a different product (if available).
- Check if VictronConnect can see the device when using a VE.Direct USB cable connected to a PC or android phone.
- Try re-pairing by first removing the pairing from the phone: go to your phone's Settings, then click Bluetooth. Click the (i)-icon next to any "VE.Direct LE" device and click "Forget This Device". Then, open the VictronConnect App again and pull down the Discovery screen to rediscover products. Set the dongle in pairing mode by clicking the button on the dongle, then click the Victron product in the app's Discovery screen. Confirm the pairing and you should now be connected to the dongle.
- In case a Motorola Moto G 2014 (aka Moto G2) is used: This model has a known issue with VE.Direct Bluetooth Smart dongles with serial number HQ1606 and earlier. If you have such serial number dongle and that phone, contact your Victron supplier for a replacement (newer) dongle.

If these steps were unsuccessful see the troubleshooting section in the [VictronConnect manual](#) for more troubleshooting information.

## 5. Warranty

This product has a 5-year limited warranty. This limited warranty covers defects in materials and workmanship in this product and lasts for five years from the date of original purchase of this product. To claim warranty the customer must return the product together with the receipt of purchase to the point of purchase. This limited warranty does not cover damage, deterioration or malfunction resulting from alteration, modification, improper or unreasonable use or misuse, neglect, exposure to excess moisture, fire, improper packing, lightning, power surges, or other acts of nature. This limited warranty does not cover damage, deterioration or malfunction resulting from repairs attempted by anyone unauthorized by Victron Energy to make such repairs. Non-compliance with the instructions in this manual will render the warranty void. Victron Energy is not liable for any consequential damages arising from the use of this product. The maximum liability of Victron Energy under this limited warranty shall not exceed the actual purchase price of the product.

## 6. Specifications

**Table 2. Product specifications VE.Direct Bluetooth Smart Dongle**

Specification	Value
Current draw when not connected via Bluetooth	1mA
Current draw when connected via Bluetooth	2.5mA
Length VE.Direct cable	1.5m

### 6.1. Enclosure dimensions

